

Parker



SERVICE
MANUAL

OCTOBER

1 9 3 3

THE PARKER PEN COMPANY

Janesville, Wisconsin, U. S. A.

TO FILL THE PARKER VACUMATIC PEN

- 1—Unscrew the small cap at the end of barrel, thus exposing the plunger button.
- 2—Release the filler plunger by pressing it in and turning it slightly to the left. Plunger will extend.
- 3—Immerse the pen point completely in ink, depress and release the filler plunger fairly rapidly about 6 times, pausing a moment after each release of the plunger. It is during this pause, while filler plunger is extended, that the vacuum created forces ink up into the pen.

You can "feel" when the pen is filled, as it is then harder to work the plunger.

Before removing pen from bottle, depress the filler plunger and re-engage it by turning the button to the right. Replace the small cap.

Note—When the Parker VACUMATIC FILLER Pen is about 9/10ths empty, ink will feed to the nib more rapidly than usual; this is the signal to refill.

Keeping the large cap tightly screwed over the pen point prevents the pen from leaking.

The Vacumatic Filler holds 102% more ink than a sac-filling pen of equal size as shown by the two test tubes illustrated opposite.

Remember, the Parker VACUMATIC FILLER is the last word in fine pens; to get the best out of it, use Quink, Parker's new quick-drying, non-clogging ink.

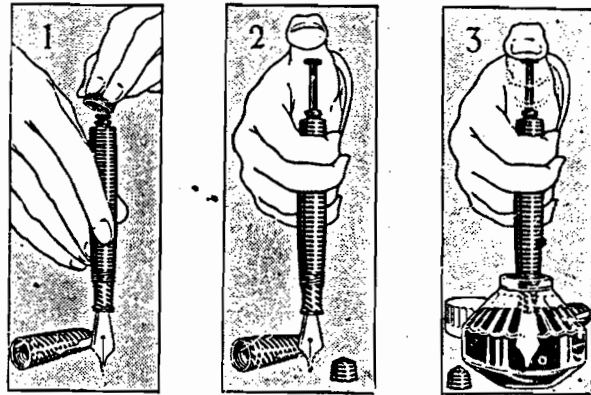

To empty the VACUMATIC FILLER Pen, release the filler plunger and push it down very slowly. The slow pressure allows the ink to be expelled in drops. Release the plunger and repeat until the pen is empty.

To clean the VACUMATIC FILLER Pen, immerse it in a glass of cold water and work plunger, in same manner as for filling, 15 or 20 times. Remove water by slowly emptying as directed above.

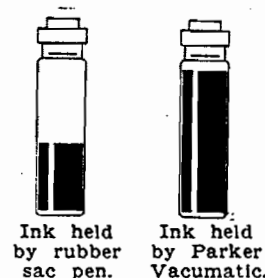

PARTS OF PARKER VACUMATIC PEN

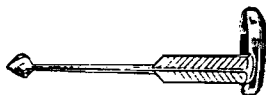
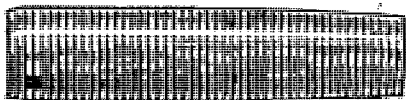
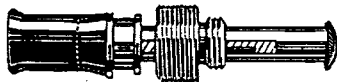
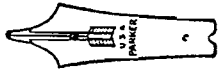

Gold Nib. Made of 14-karat gold, plated with platinum, tipped with highest quality iridium. This iridium will show no wear after many years of service.

Tube Feed. Both feed and breather tube are made of fine hard rubber.

Barrel. Made of laminated unbreakable pyroxylin. Patented, exclusively Parker.

Filler Unit. Main parts are made of brass, chromium plated. The spring is stainless steel. The threaded bushing which screws into the barrel is aluminum.

Blind Cap. Made of laminated unbreakable pyroxylin. The band is covered with rolled gold.

Outer Cap. Made of laminated unbreakable pyroxylin, mounted with gold plated bands, yellow or white gold. The inside is fitted with an inner cap which provides an air-tight chamber for the nib when the pen is closed.

Clip. Made of optical spring metal covered with rolled gold.

Ring Crown. Made of optical spring metal covered with rolled gold.

White gold clips are covered with rolled gold. In addition they are plated with chromium for protection and higher luster.

Clip Screw. Made of pyroxylin. To reinforce it against shrinkage, a rubber plug is fitted inside. Its use in holding clip allows the pen to set low in the pocket.

X-RAY PHOTOGRAPH OF THE PARKER VACUMATIC PEN

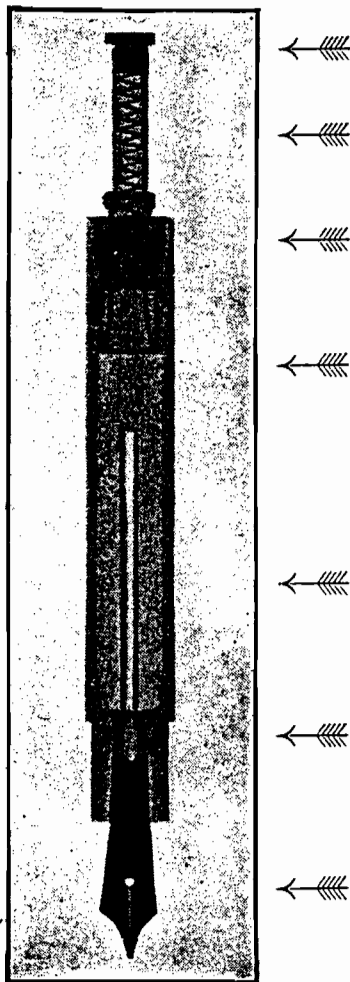

Study this x-ray photograph of the Vacumatic Filler Pen.

The plunger of the filler unit is released, showing the stainless steel spring contained therein.

The dark portion is the threaded bushing of aluminum by which the filler unit is screwed into the barrel.

The light portion is the rubber diaphragm which is attached to the filling mechanism.

In the center is the breather tube, through which ink enters and air escapes during the filling process.

The breather tube is inserted into the feed and connects with the airhole.

The Vacumatic Filler nib is made of solid 14-karat gold and plated with platinum.

Because of its advanced fool-proof filling principle, the Parker Vacumatic Filler will rarely need repair service. Vacumatic Filler test models being tried out in our research laboratory have withstood 160,000 fillings without showing any wear or defect.

In exceptional cases where, after long service, the filler unit should cease to function properly, it will be an easy matter for a dealer to replace the old filler unit with a new one.

To remove clip screw, place a flat piece of soft rubber in palm of hand, press outer cap with clip screw against it and turn palm to left. Reverse the procedure for tightening the clip screw.

The Parker Vacumatic Filler contains no ordinary rubber sac, no piston, no valves, no packing. For that reason it will outlast any sac-filling fountain pen and should easily last a lifetime.

TO REPLACE THE FILLER UNIT.

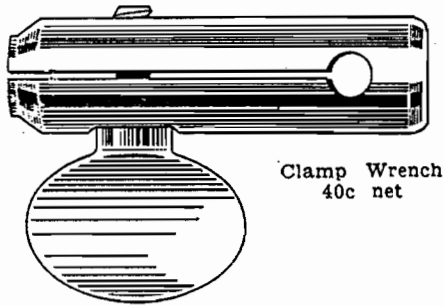

Clamp Wrench
40c net

A small special clamp wrench is available for servicing Vacumatic Filler pens. This tool fits over the part of the filler unit which projects from the barrel. With it the old filler unit can easily be screwed out.

After removal of the old filler unit brush out and clean the threads inside the barrel.

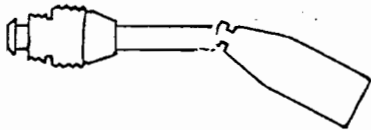
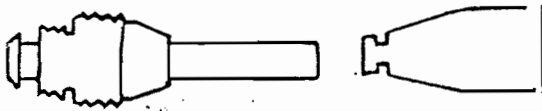

The filler unit consists of the filling mechanism and the diaphragm. To insert the diaphragm requires a little practice.

Hold the diaphragm with thumb and forefinger in such a manner that the finger nails will go into the groove between the nipple and the main part.

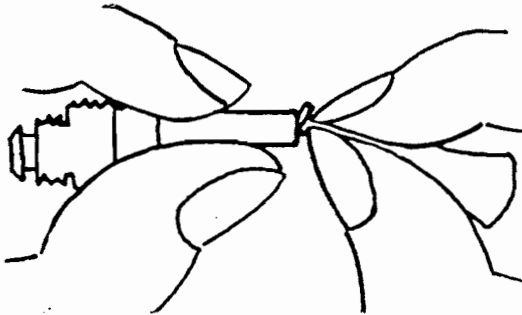

Insert an edge of the nipple into the hole of the plunger. Now, turning the nipple as if to screw it in, press it into the hole.

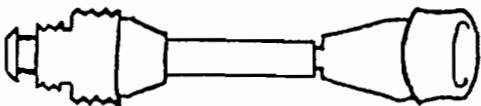

After the nipple has been entirely inserted in the plunger, fold the diaphragm back over the plunger to its correct position. This is done simply by turning the diaphragm inside out and pushing it up on the plunger.

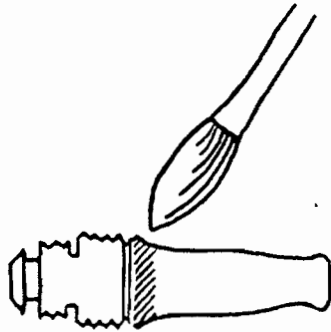

Before inserting the new filler unit into the barrel, with a fine brush apply some diaphragm lubricant to the upper part of the diaphragm, indicated by the shading in the illustration.

This application of lubricant is necessary to prevent the diaphragm from sticking to the wall of the barrel and becoming twisted, when the filler unit is screwed into the barrel. The lubricant allows the diaphragm to turn evenly with the rest of the filler unit. Caution: use only very little lubricant.

The diaphragm lubricant is furnished in small bottles at a cost of 5c net each. The lubricant consists of—

30 parts Gum Tragacanth

1 part Phenol

dissolved in 1,000 parts Water.



Small Bottle of
Diaphragm Lubricant
5c net

Before inserting a new filler unit, apply a little shellac to the threads so that it will stick tight after it is screwed in.

Care must be taken, when inserting the filler unit, to start the screw threads of the bushing squarely. Continue to screw in the bushing with the clamp wrench, until it is firmly set in the barrel.

TO REFINISH OR SMOOTH UP IRIDIUM TIP

Sometimes it is necessary to change the writing character of the nib to suit the particular style of handwriting of a customer. The customer may hold the pen in a peculiar fashion when writing or exert pressure sideways on the nib with the result that it will not write as smoothly as when held in normal position.

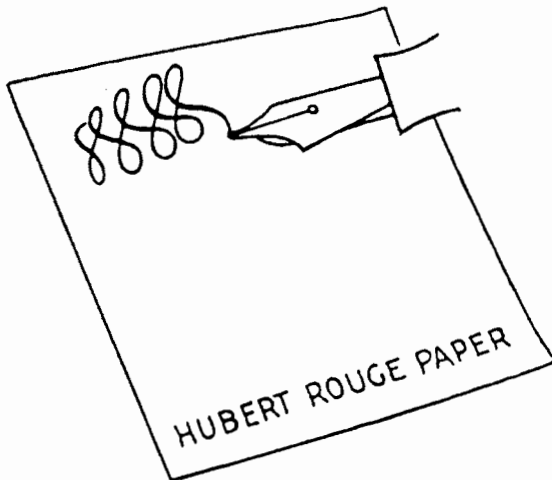

4c net per sheet

We have found an excellent medium, "Hubert Rouge Paper", with the aid of which dealers can in a few seconds' time smooth out all nibs. Simply run the point of the gold nib back and forth on this Hubert Rouge Paper, or, better yet, write continuous "figure eights" on it, holding the pen in the writing position the customer will use. In a few seconds the nib will be polished smooth.

Warning: Do not use coarse abrasive paper to smooth the nib. It would spoil it.

The Hubert Rouge Paper is supplied at 4c net per sheet.

TO REMOVE GOLD NIB

Grasp the nib and feed firmly between thumb and finger of the right hand. To protect your fingers, a piece of rubber tubing may be slipped over the nib and the feed. Pull outward, and, at the same time, turn the holder back and forth. This will loosen the nib so that it may be pulled out.

When the nib is fitted tightly, a pair of Bernard pliers (pliers with parallel opening jaws) may be used to remove it. It is important that a piece of rubber tubing be inserted between the jaws to protect the gold nib from damage.

When pulling out the nib and feed with pliers, use a slight rolling action. This helps to loosen the nib.

Bernard Pliers
\$1.35 net

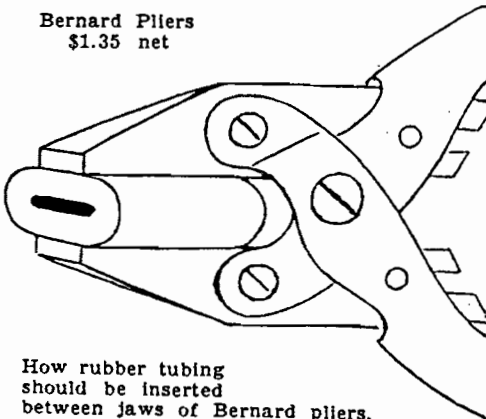

How rubber tubing should be inserted between jaws of Bernard pliers.

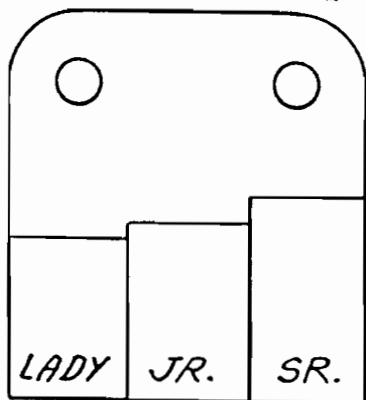
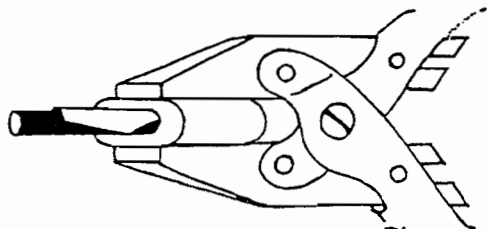

Gauging Plate
40c net

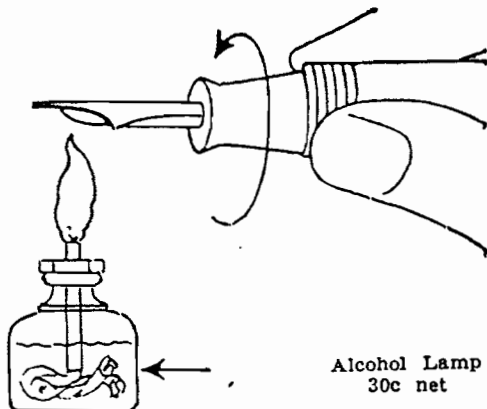

Alcohol Lamp
30c net

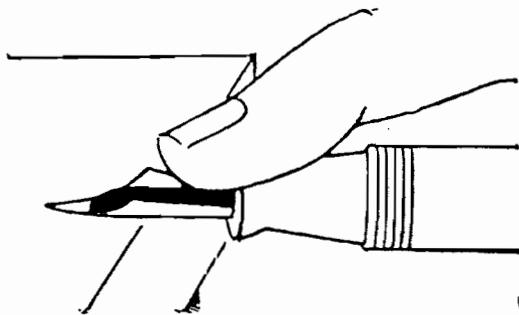

TO FIT A GOLD NIB

Place the gold nib over the feed in correct position and grab both with pliers fitted with rubber tubing; push both nib and feed into section of pen until lettering on the gold nib is about one-quarter inch from the section.

A small gauging plate is available which allows you to measure exactly how far the nib is to be pushed into the section. On this gauging plate is indicated the distance which the three sizes of nibs—Senior, Junior, Lady—should extend out of the section.

TO "SET" A NEWLY FITTED NIB

For an even flow of ink it is essential that the feed should lie snugly and tightly against the gold nib.

To achieve this, pass the forepart of feed a few times over a small flame. Do not hold it still in flame as it may burn.

Now rest the back of the section on the edge of a desk or table. Dip the forefinger in cold water and rub it back and forth on the warm feed until it is cooled, pressing it at the same time against the nib. Then dip the feed into cold water to "set". This makes the feed preserve its shape and conform with the nib.

Make certain that the prongs of the nib are even and together at the iridium point, so that they will not scratch while writing.

TO FIT THE FEED

Make sure that the feed is correctly fitted.

When the feed is pushed too far into the section, ink does not reach the nib evenly and the pen will not write properly.

When the feed extends too far out on the nib, ink will flow too freely and blot.

The channel of the feed has a groove in the center through which ink is attracted to the writing point by capillary action.

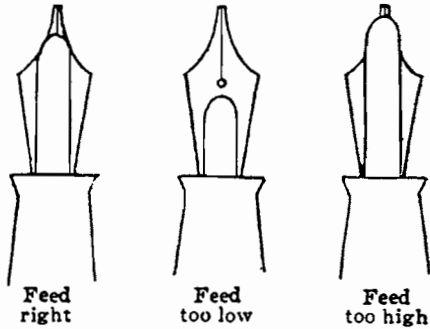

Cross section of nib on feed

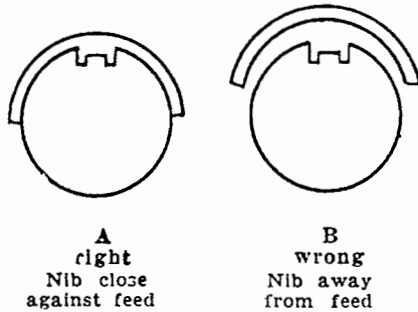

The smooth flow of ink will take place only when the nib fits closely against the feed. (Figure A) Ink is under control because it is confined in the ink channel.

When a space is left between nib and feed, ink will fill the space and destroy the action of the channel, with the result that the volume of ink and its rate of flow is out of control. (Figure B)

TO REGULATE FLOW OF INK

When a pen flows too freely, it may be because the feed is pulled away from the nib. Heating the feed down as described above will remedy this.

The excess flow of ink may be caused by the feed being fitted too high on the nib. Pushing the feed farther into the section will decrease the flow.

A space is left between the prongs of rigid gold nibs to insure an easy flow of ink. When prongs are spread too much, ink will flow too freely; when prongs are closed too tightly, ink will feed only when pressure is exerted.

The flow of ink can be regulated by adjusting the prongs of the gold nib with the thumb nail.

To increase the flow, elevate each prong of the gold nib, one prong at a time. Another method is to place the back of the nib below the air hole against the edge of a desk or table. Then with the thumb, press firmly down on the feed. This will loosen the tension of the nib.

To decrease the flow, bend down each prong of the gold nib. This closes the spacing.

Only an experienced person can adjust the ink flow of the nib with a pair of small pliers. The jaws of these pliers must be especially ground to a thin tip. Care must be taken to keep pliers away from the iridium tip of nib. An inexperienced person is likely to break off the iridium when trying to bend the prongs with the pliers. It is therefore safer to use the thumb nail.

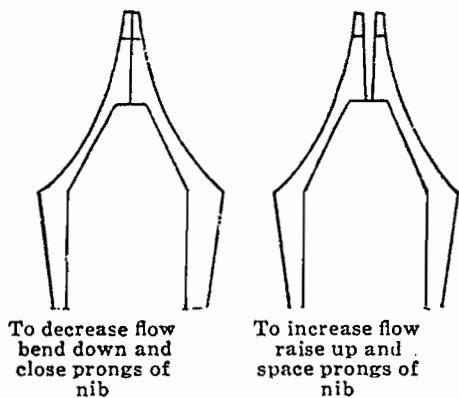

To decrease flow
bend down and
close prongs of
nib

To increase flow
raise up and
space prongs of
nib

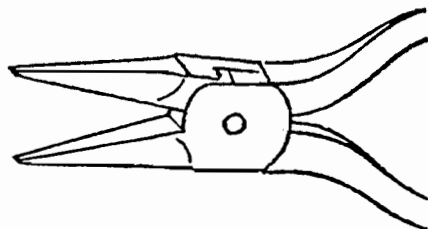

Flat Nose Pliers
ground to a thin point
\$1.35 net



41 YEARS OF PARKER PENS

The Parker Pen Company was founded in 1892. Back of each Parker product is over forty-one years of experience in the manufacture of fountain pens by The Parker Pen Company.

Parker pens are in the hands of over twenty-eight million satisfied users.